

PCCD023 | DATASHEET

Catadioptric lenses for 360° top and lateral view with just one camera



KEY ADVANTAGES

360° imaging with just one camera

Complete top and lateral view without multiple cameras

Compactness

The lens can be easily held and integrated in any vision system

Extra wide lateral viewing angle

Perfect chromatic correction

For RGB camera applications and color inspections



PCCD series features catadioptric lenses exclusively developed and manufactured by Opto Engineering® to enable the 360° top and side view of objects with a single camera. Their innovative optical design, based on a catadioptric system, makes it possible to image objects of different diameters, ranging from 7.5 mm to 110 mm.

SPECIFICATIONS

Optical specifications

Image circle	(mm)	6.6
Min sensor size		2/3"
Working distance with minimum object size ³	(mm)	50.5
Working distance with medium object size ³	(mm)	9.2
Working distance with maximum object size ^{2,3}	(mm)	0
f/N ⁴		1.4 -C
Viewing angle	(°)	35

Mechanical specifications

Mount		C
Length ⁵	(mm)	108.5
Diameter	(mm)	143.0
Mass	(g)	994

FIELD OF VIEW

Field of view (diameter x height)

Minimum ¹	(mm x mm)	7.5 x 4.2
Medium ¹	(mm x mm)	35.0 x 24.2
Maximum ^{1,2}	(mm x mm)	75.0 x 2.5

¹ For the complete information about the inspectable field of view, see the datasheet of the objective.

² The maximum inspectable field of view is given considering zero working distance. Depending on the application, a working distance greater than zero will decrease the height of the inspectable object accordingly.

³ Working distance: distance between the front end of the mechanics and the object.

⁴ The f-number could be changed using the variable iris.

⁵ Measured from the front end of the mechanics to the camera flange.

COMPATIBLE PRODUCTS

Full list of compatible products available [here](#).



A wide selection of innovative machine vision components.

All product specifications and data are subject to change without notice to improve reliability, functionality, design or other. Photos and pictures are for illustration purposes only. Data are reported by design, actual lens performance may vary due to manufacturing tolerances.

Image Resolution

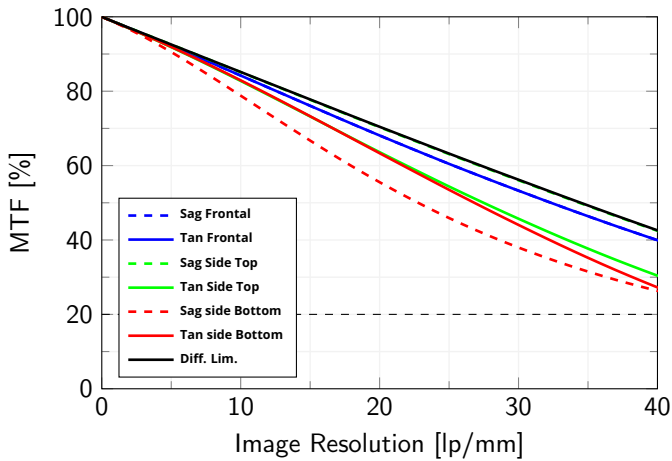

Modulation Transfer Function (MTF) vs. Image Resolution, wavelength range 486 nm - 656 nm at $wf/1.4$ -C of cylindrical object of diameter 25 mm and height of 17 mm

PCCD IMAGING SETUP

The image of the external walls of the object, captured through the catadioptric system, is inscribed into the short side of the camera detector within a circular crown. On the other hand, the top of the object is directly imaged onto the central part of the detector area: both the lateral and top view of the object are in perfect focus at the same time.

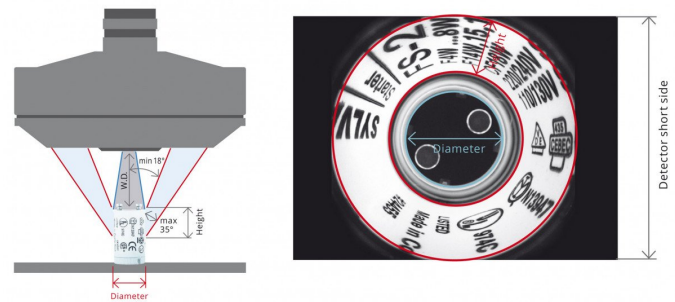

RECOMMENDED ACCESSORIES

Opto Engineering® Suggests the following accessories when using PCCD Lenses:

- **PCCDLFAT**, interchangeable attachment for extra-wide TOP view. By replacing the pre-assembled protective window on PCCD0xx, PCCD2M and PCCDL with the PCCDLFAT attachment, the TOP view of the object is increased.
- **CMHOPCCD**, clamping mechanics for PCCD0xx and PCCD2M lenses.



PCCD optics with CMHOPCCD



PCCDLFAT assembling

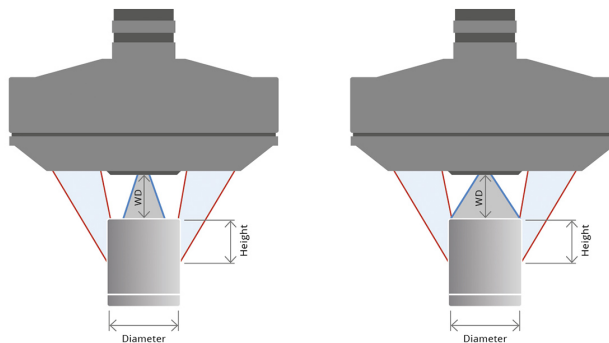

PCCD optics (left) and PCCD optics with PCCDLFAT (right)

All product specifications and data are subject to change without notice to improve reliability, functionality, design or other. Photos and pictures are for illustration purposes only. Data are reported by design, actual lens performance may vary due to manufacturing tolerances.

Field Of View

Diameter [mm]	Height [mm]	Working distance [mm]	Top view [mm]	Working distance with PCCDLFAT [mm]	Top view with PCCDLFAT [mm]
7.5	4.2	50.5	22.9	47.2	78.9
10	6.1	46.7	22.3	43.4	73.9
15	9.7	39.2	21.2	35.9	63.9
20	13.3	31.7	20	28.4	53.9
25	17	24.2	18.8	20.9	44
30	20.6	16.7	17.7	13.4	34
35	24.2	9.2	16.5	5.9	24
40	27.9	1.7	15.3	0	16.2
45	25.7	0	15	-	-
50	21.9	0	15	-	-
55	18	0	15	-	-
60	14.1	0	15	-	-
65	10.3	0	15	-	-
70	6.4	0	15	-	-
75	2.5	0	15	-	-